

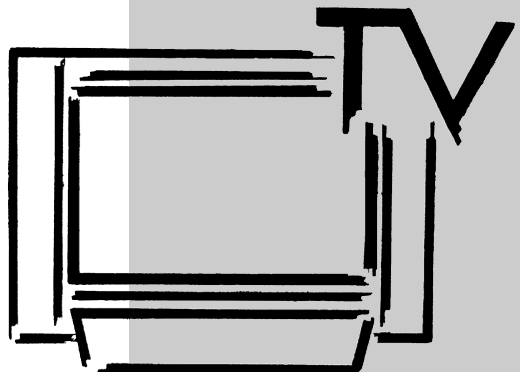

30 LCD-TV PIP
Operating Instructions

30TL55



Thank you

Contents

Dear Customer,
thank you for selecting this Metz
product.

In this TV set, we have provided
a menu guidance system which,
we believe, will permit you to
operate the set easily.

However, before using the set for
the first time, you should at least
read Sections 1 to 7 of these
Operating Instructions.

Your METZ-WERKE

The TFT-LCD screen is a high-
technology product with about
one million integrated foil trans-
istors which provide a high-
resolution picture.

Occasionally, some inactive
pixels may appear on the screen
as fixed blue, green or red dots.
Please note that these do not
affect the performance of the TV
set.

1.	Setting up	3
2.	Safety notes	5
3.	The remote control	6
4.	Day-to-day operation	12
5.	Selecting your country	13
5.1	Selecting a language	14
6.	Tuning to TV stations	15
6.1	Station logos	19
6.2	Sorting the stations	20
7.	Selecting a station	21
8.	Picture settings	22
9.	Sound settings	23
10.	Special functions	24
	Picture in picture (PIP)	24
	Picture size	25
	Split screen	26
	Freeze frame	26
	Sleep timer	27
	Displaying the time	27
11.	Teletext	28
12.	AV devices	29
	Connection facilities	29
	AV mode	30
	Copying recordings	32
	VCR function	33
13.	Operation without the remote control	34
13.1	Key lock (child lock)	35
14.	Connecting headphones	35
15.	Cleaning the TV set	36
16.	Technical data	37
	Disposal of batteries	38
	Troubleshooting	39
	Code list	40

1. Setting up

The TV is delivered complete with base and wall bracket.

Fitting the base

Slide the base into the slots provided for it and secure it carefully with four screws (M4 x 16mm).

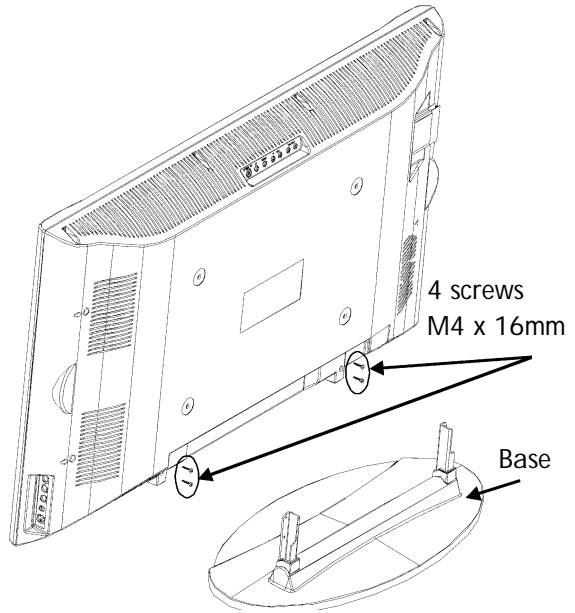

Wall mounting



Non-compliance with these instructions can result in serious injuries to persons and/or major damage to the TV set.

The TFT monitor may be mounted only on vertical walls, using the wall bracket.

Never attempt to mount the wall bracket and the monitor on your own; always obtain the assistance of a second person.

- Take great care when securing the wall bracket to the wall. The bracket must not only support the monitor under normal circumstances, but must also withstand any shocks, vibration, etc. which may occur.
- Before starting work, check the stability and thickness of the wall. Ask your local DIY store for suitable metal screws and wall plugs.
- The wall must be solid and capable of handling the load (i.e. it must be made of bricks, limestone blocks, concrete or similar materials).
- **If the wall is made of other materials** (such as wood, plasterboard, etc.) have the wall bracket mounted by an experienced tradesman.

1. Setting up

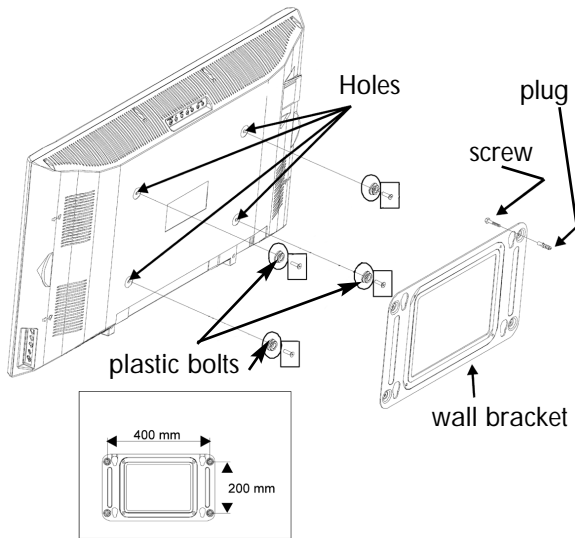

Wall mounting

Remove the base (if it is fitted).

- Remove the four caps from the rear side.
- Insert the enclosed plastic bolts in the holes and carefully secure each one with a screw M6x20 mm.
- Hold the wall bracket against the wall at the desired position and mark the positions of the four mounting holes.
- Screw the wall bracket to the wall with wall plugs and screws.
- Insert the plastic bolts on the TV set into the keyholes of the bracket and push the TV set fully downwards.

- Take care that no bright lights (including sunshine) shine directly on the screen, since this can cause reflections and reduce the apparent brilliance of the picture.
- The best viewing distance is about five times the diagonal dimension of the screen. For a TV set with a 75 cm screen, it is thus about 3.75 m.
- All cables and components connected between the antenna/broadband socket in the wall and the TV set must comply with European Standard EN 60966-2-4.
- There may be no magnetic fields in the immediate vicinity of the TV set. External loudspeakers should thus be positioned at a suitable distance from the set.
- The antenna connection cable used for the set should have a screening attenuation of at least 75 dB.
- The use of unapproved cables and components will invalidate the type approval of the TV set.

2. Safety notes

- Place the TV set on a solid surface which is capable of bearing the weight!
- If you bring a cold TV set into a warm room, wait until any condensation has evaporated before switching it on.
- The TV set is intended for use in dry rooms. If, in exceptional cases, you want to use it outdoors, take care that it is not exposed to moisture (rain, splashwater, dew).
- TV sets need sufficient cooling to prevent them from overheating. Ensure that the slots in the rear cover are not blocked by curtains, doily, newspapers, etc. Also keep the slots on the bottom of the set free so that cool air can enter the set.
- If you install the TV set in a wall cabinet, ensure that there is sufficient space around it to permit the circulation of cooling air.
- Do not position the TV set in the immediate vicinity of a radiator or other heater, since this could cause it to overheat.
- Do not place
 - burning candles
 - vases, etc. containing liquidson or above the TV set. Hot wax or other liquids which enter the set will destroy its electronic components. In such cases, safe operation of the set is no longer guaranteed.
- Thunderstorms can damage electrical devices. Lightning hitting overhead power cables or the antenna can cause considerable damage to the set, even if it is switched off. If there is a risk of a thunderstorm, you should
 - remove the power cable from the wall outlet and disconnect the antenna cable from the outlet or from the TV set.
- Only suitably trained persons may open the set and/or carry out repairs.

CAUTION: RISK OF ELECTRIC SHOCKS!

If repairs should be necessary, please consult your local dealer.

- Always switch off the TV set with the mains switch before cleaning it!
- Do not point the remote control into your eyes and press any keys. The infrared radiation can damage your eyes!
- Do not use rechargeable batteries in the remote control. Use only two dry batteries of the type LR03/AM4/AAA 1.5V Micro.
- The TV set is intended only for the reception and display of picture and sound signals.
- The TV set may be operated only from a mains voltage of 220 – 240VAC ~, 50Hz.
- Lay the mains cable so that no-one can trip over it and so that no objects (furniture, etc.) stand on it!
- Repairs may be carried out only by suitably qualified persons.

3. The remote control

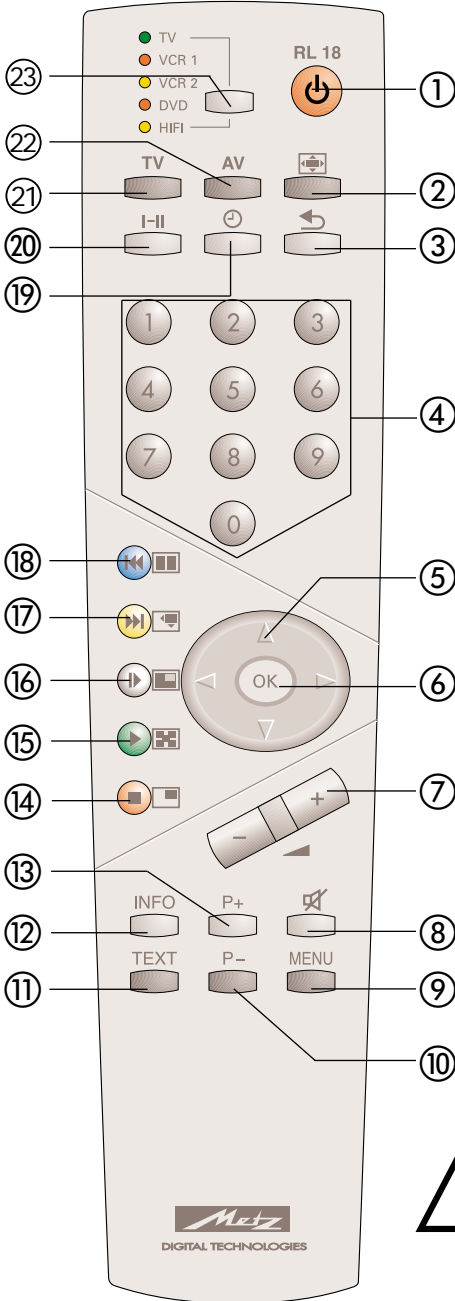

The Metz Remote Control RL 18 can be used to control the TV set and the basic functions of video recorders VCR1 and VCR 2, a DVD player and HiFi units (such as radio, cassette player, CD player, amplifier, etc.) made by Metz or various other manufacturers.

The remote control sends the commands to the TV set with the aid of infrared radiation. Always point the remote control at the TV set when using it. The remote control may occasionally interfere with the operation of other infrared-controlled devices or systems (such as infrared headphones) within its range.

Ensure that no sunlight falls directly on the TV set, since this may result in malfunctions because the set cannot detect the infrared signals from the remote control.

Note that the TV set must be switched on with the mains switch before it can be controlled with the remote control.

The various operating levels of the remote control are programmed as follows in the factory:

- TV** Metz TV sets 30TL55
- VCR1** Metz VCR with remote control RH51
- VCR2** Metz VCR with remote control RF52
- DVD** Metz DVD player with remote control RG/RH37
- HiFi** Metz HiFi CD receiver HE 11 with remote control F11



Do not use rechargeable batteries in the remote control.

Use only two dry batteries of the type LR03/ AM4/AAA 1.5V Micro.

3. The remote control

Overview of the key functions

- ① ON
at the programme position selected
when the set was switched off
OFF (standby)
- ② Select aspect ratio (picture format)
- ③ Back to previous programme position
- ④ Numeric keys (direct programme
selection)
- ⑤ Cursor key for menus
- ⑥ OK (confirm) / Freeze frame
- ⑦ Volume - +
- ⑧ Mute
- ⑨ Open TV menu
- ⑩ Programme -
- ⑪ Open Teletext
- ⑫ Display/hide programme list
- ⑬ Programme +
- ⑭ Display/hide picture in picture (PIP)
- ⑮ Change PIP position
- ⑯ Exchange contents of PIP and main
picture
- ⑰ Change size of PIP picture
- ⑱ Split screen (display/hide double pic-
ture)
- ⑲ Display the time
- ⑳ Select Mono - Stereo + Dual tone.
- ㉑ Back to TV mode
- ㉒ Select video input signal
- ㉓ Select key – Switches to the operating
level for AV devices

3. The remote control

1. Programming the remote control for the individual devices



In order to control your various devices with the remote control, you must first programme it with a three-digit number for each operating level.

- TV (TV set)
The TV operating level is programmed in the factory for the Metz 30 LCD-TV PIP. You cannot enter any other code.
- VCR 1 (video recorder 1)
VCR 2 (video recorder 2)
DVD player
HiFi (e.g. amplifier, tuner, tape, etc.)
The remote control must be programmed with suitable codes from the code list.

 **Note the factory settings (page 6) and see the code list at the end of this manual.**





1.1 Entering the codes for VCR and DVD

 **After executing steps a) to c), you have about 15 seconds to make further entries. If you do not do so, the remote control returns automatically to the TV operating level.**

- a) Use the Select key to select the desired operating level. The coloured LED for the selected level lights.
- b) Press and hold the keys  and  until the LED blinks twice.
- c) Enter the appropriate code (see the code list) with the **numeric keys**.
If the code is accepted, the LED again blinks twice. If you enter a non-existent code, the LED lights once for about two seconds.

1.2 Entering the codes for CD player, tuner and tape

 **After executing steps a) to c), you have about 15 seconds to make further entries. If you do not do so, the remote control returns automatically to the TV operating level.**

- a) Use the Select key to select the operating level HiFi. The coloured HiFi LED lights.
- b) Press the , release it and then press the key:
...  for CD player,
...  for tuner (radio) or
...  for tape (cassette recorder)
on the remote control until the LED blinks once.
- c) Enter the appropriate code (see the code list) with the **numeric keys**.
If the code is accepted, the LED again blinks twice. If you enter a non-existent code, the LED lights once for about two seconds.

3. The remote control

1.3 Entering the code for a HiFi amplifier

☞ *After executing steps a) to d), you have about 15 seconds to make further entries. If you do not do so, the remote control returns automatically to the TV operating level.*

- Use the Select key to select the operating level HiFi. The coloured HiFi LED lights.
- Press the ☺ key, release it and then press the ➔ key until the LED blinks twice.
- Press the I-II key. The LED blinks once.
- Enter the appropriate code (see the code list) with the **numeric keys**. If the code is accepted, the LED again blinks twice. If you enter a non-existent code, the LED lights once for about two seconds.

1.4 Search function

Proceed as described above for input of the code for VCR, DVD, CD, tuner or tape until you reach the step where the code number is entered. Now enter the code "001" to select the search function. The LED blinks twice. Then press the search key (the actual key depends on the operating level; see the table on pages 10 and 11) and hold it until the device stops or switches off (an Off or STOP command is transmitted automatically every 1.5 seconds).

Now release the Search key and press the Select key to save the code which was found.

At the end of the search, when all existing codes have been interrogated, the corresponding LED blinks five times.

2. Reading out a programmed code

☞ *After executing steps a) to e), you have about 15 seconds to make further entries. If you do not do so, the remote control returns automatically to the TV operating level.*

- In order to see which code is programmed for an operating level, first proceed as described in 1.1 a) to b).
- Use the numeric keys to enter ① ① ②. The LED blinks twice to acknowledge the input.
- Press numeric key ① to display the first digit of the code. The LED now blinks several times to show the value (e.g. the LED blinks three times: the digit 3 is programmed).
- Press numeric key ② to display the second digit of the code. The LED now blinks several times to show the value (e.g. the LED does not blink: the digit 0 is programmed).
- Press numeric key ③ to display the third digit of the code. The LED now blinks several times to show the value (e.g. the LED blinks seven times: the digit 7 is programmed).

In this example the programmed code is thus ③ ① ⑦.

If you lose track during this operation, simply start again at step 2c).

3. The remote control

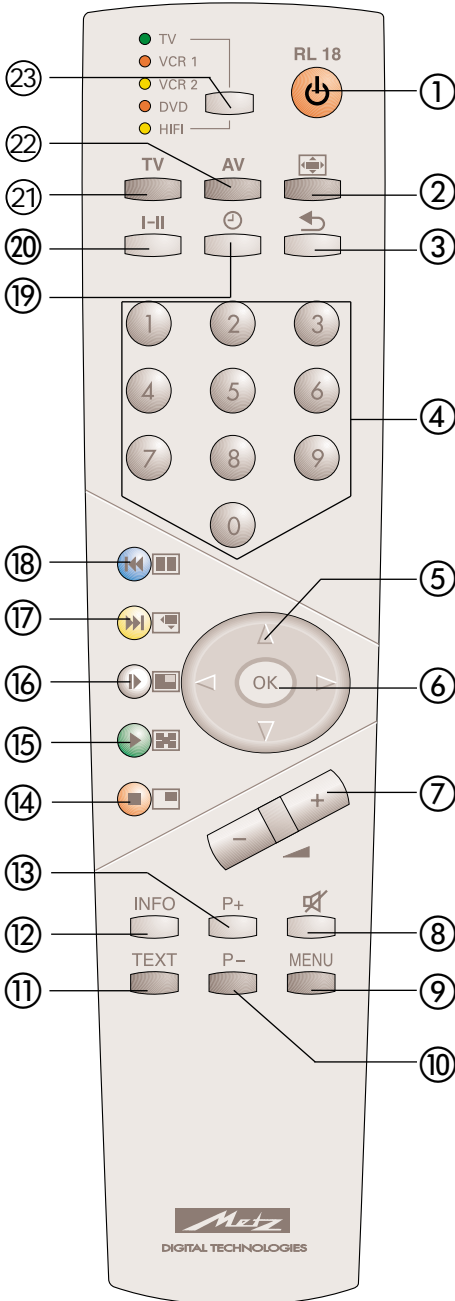



Key		VCR 1 / 2
①	On	On / Standby
②		Record
③		Time in display
④	0...9	Numeric keys: progr. selection
⑤	▲▼	Programme +/-
	◀▶	Fast forward / Rewind
⑥	OK	OK
⑦	Vol.+/-	Lautstärke +/- TV
⑧	Mute	TV mute
⑨	Menu	MENU
⑩	P-	Switching voltage on/off
⑪	Text	
⑫	Info	Disp./hide programme list
⑬	P+	Pause
⑭	red	STOP / Search
⑮	green	PLAY
⑯	white	Slow-motion
⑰	yellow	
⑱	blue	
⑲		
⑳	I-II	
㉑	TV	
㉒	AV	AV - Eingang
㉓	Select	Auswahl Bedienebene

Note:

The above key assignments are true for the AV devices programmed in the factory. If other AV devices shown in the code list are used, the assignments may be different and some may not be available.

3. The remote control

Key		DVD	HiFi		
			CD (I-II)	TUNER (⊙)	TAPE (↶)
①	On	On / Standby	ON: Display time/track ON&AV, ON:On/Standby	ON:Radio-text on/off ON&AV, ON: On/Standby	
②		Return			
③		Angle		I-II & ON: CD	I-II & ON: CD
④	0...9	Numeric keys: title selection	Num.keys: title select.	Num.keys: progr.select.	
⑤	▲▼	Cursor up/down	Title +/-	Programme +/-	
	◀▶	Cursor left/right		Frequency +/-	
⑥	OK	OK / Enter			
⑦	Vol.+/-	TV volume +/-	AMP volume +/-	AMP volume +/-	AMP volume +/-
⑧	Mute	TV mute			
⑨	Menu	MENU			
⑩	P-	Title			
⑪	Text	Display			
⑫	Info				
⑬	P+	Pause	Pause		
⑭	red	STOP/Search	STOP/OPEN-CLOSE/Search	Num.key ②=Search	Search
⑮	green	PLAY	PLAY		
⑯	white	EJECT			
⑰	yellow	Skip +			
⑱	blue	Skip -			
⑲		Audio	⊙ & ON: Tuner		⊙ & ON: Tuner
⑳	I-II	Subtitle	↶ & ON: Tape input	↶ & ON: Tape input	
㉑	TV				
㉒	AV	Repeat	AUX input	AUX input	AUX input
㉓	Select	Select operating level	Select operating level	Select operating level	Select operating level

Search:

Proceed as described above for entering the codes for VCR, DVD, CD, tuner, tape as far as the step where the code number is entered. Then enter "001" for the search function. The LED blinks 2x to acknowledge the input. Then press and hold the search key (which depends on the operating level; see the table) until the device stops or switches off (a STOP or OFF command is automatically transmitted every 1.5 seconds).

Then release the search key and press the Select key to save the code which was found.

Reset:

Proceed as described above for entering the codes for VCR, DVD, CD, tuner, tape as far as the step where the code number is entered. Then enter "000" for the reset function. The LED blinks 2x to acknowledge the input. All codes are now reset to the factory default settings.

The reset is executed for all operating levels, regardless of the level from which it is initiated.

4. Day-to-day operation

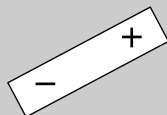
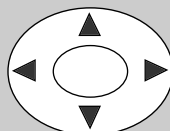

Switching on

Switch on the TV set with the mains switch. It is now in the standby state and the red standby indicator lights. Select any desired programme position with the **numeric keys** on the remote control.





Alternatively, you can switch on the TV set by pressing the  key. In this case, the programme you were watching when the TV set was switched off is again selected.

Switching off

Press the  on the remote control to switch the set to the standby state or switch the set off completely with the mains switch.

Programme selection

You can select the programme positions with the numeric keys, by stepping through the positions with the "P+" and "P-" keys or by selecting a programme from the station table.

Open the station table by pressing the "INFO" key, use the cursor key     to select the desired station and press the "INFO" key to close the station table.

Adjusting the volume

The volume can be adjusted with the - + key.

5. Selecting your country

Open the menu

Once you have installed the TV set, you must specify the country in which it is located (e.g. UK) to assign certain basic settings (such as the TV channel frequencies).

Selecting your country:

- Press the "**MENU**" key to open the TV menu.
- Use the cursor key **▶** to select the menu "Settings".
- Use the cursor key **▼** to select the menu item "TV tuner" and press the "**OK**" key to open it.
- Use the cursor key **◀▶** to select the sub-menu "APS".
- Use the cursor key **▶** to select the menu item "Country".
- Use the cursor key **◀▶** to select the desired country from the list.
- Press the "**TV**" key to close the TV menu.

 **The setting is saved automatically when you close the menu.**

MENU

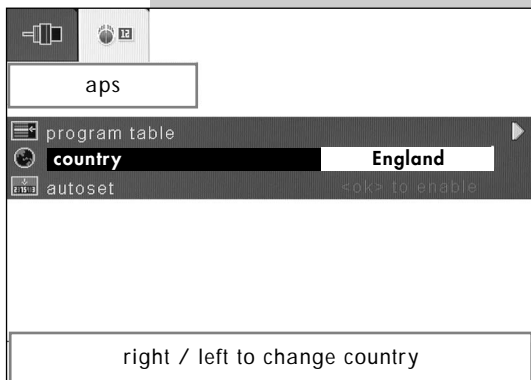
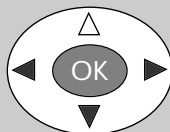

TV



Open the menu

5.1 Selecting a language

Language selection for the TV menu

You can select any of the available languages for the TV menu. All text in the menu and the help screens (Information) are displayed in the selected language.

Selecting the language:

- Press the "**MENU**" key to open the TV menu.
- Use the cursor key **▶** to select the menu "Options".
- Use the cursor key **▼** to select the menu item "Language".
- Use the cursor key **◀▶** to select one of the languages from the list.
- Press the "**TV**" key to close the TV menu.

MENU

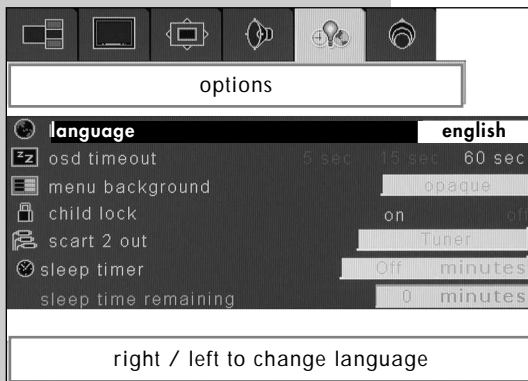
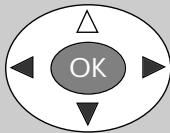

 **The setting is saved automatically when you close the TV menu.**

TV



6. Tuning to TV stations

Open the menu

You can tune your TV set to TV stations in three different ways:

a) Automatic Programme Search (APS)

The automatic programme search searches the entire range of channels for TV stations. All stations which are found are placed in a station table which is displayed at the end of the search. If you do not like the order in which the stations appear in this table, you can move stations to other positions and/or delete unwanted stations. For further details, see Section 9, "Sorting the stations".

Executing an automatic programme search

- Press the "MENU" key to open the TV menu.
- Use the cursor key ► to select the menu "Settings".
- Use the cursor key ▼ to select the menu item "TV tuner".
- Press the "OK" key and open the sub-menu "Programming".
- Use the cursor key ► to open the sub-menu "APS".
- Use the cursor key ▼ to select the menu item "Auto setting".
- Press the "OK" key. You are then asked if you really want to start the programme search.
- Press the "OK" key again to start the search..
- A station table containing the results of the search is displayed.
- You can delete any unwanted stations from the table by selecting them with the cursor key and pressing the red key.

👉 ***The settings are saved automatically when you close the TV menu.***

MENU

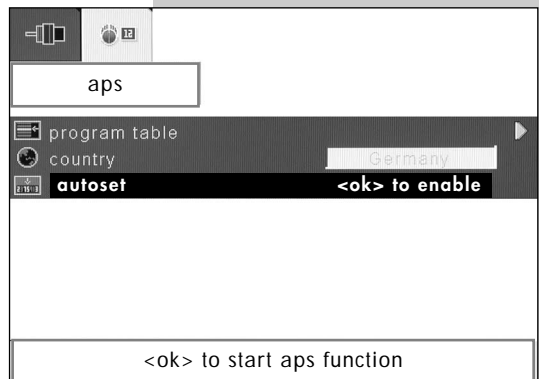
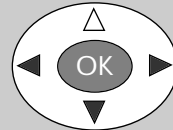

Open the menu

6. Tuning to TV stations

b) Manual search

You can use the manual search function to search for individual stations whose channel number or frequency you do not know.

Executing a manual search

- Press the "**MENU**" key to open the TV menu.
- Use the cursor key **▶** to select the menu "Settings".
- Use the cursor key **▼** to select the menu item "TV tuner".
- Press the "**OK**" key and open the sub-menu "Programming".
- Use the cursor key **▼** to select the menu item "Manual search".

MENU

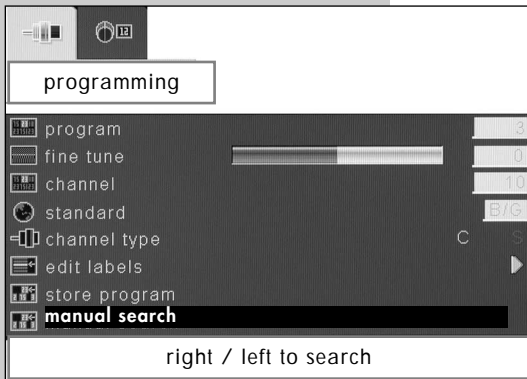
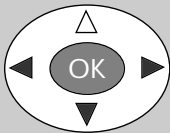

TV



- Use the cursor key **▶** to start the search.
- The search halts when a station is found.
- If you wish to save this station, use the cursor key **▲** to select the menu item "Save programme".
- Use the cursor key **◀▶** to save the station which was found.
- Press the "**TV**" key to close the TV menu.

 **You can change the station logo: see Section 6.1.**

6. Tuning to TV stations

Open the menu

c) Direct channel input

If you know the channel number of a station you want to save, you can enter this number directly.

Executing direct channel input

- Press the "**MENU**" key to open the TV menu.
- Use the cursor key ► to select the menu "Settings".
- Use the cursor key ▼ to select the menu item "TV tuner".
- Press the "**OK**" key and open the sub-menu "Programming".
- Use the cursor key ▼ to select the menu item "Channel type".
- Use the cursor key ► to set the desired channel type (C = normal channel / S = special channel).
- Use the cursor key ▲ to select the menu item "Channel" and enter the channel number with the **numeric keys**.
- Use the cursor key ▼ to select the menu item "Save programme".
- Use the cursor key ◀▶ to save the entered station.
- Press the "**TV**" key to close the TV menu.

👉 **You can change the station logo:**
see **Section 6.1**.

MENU

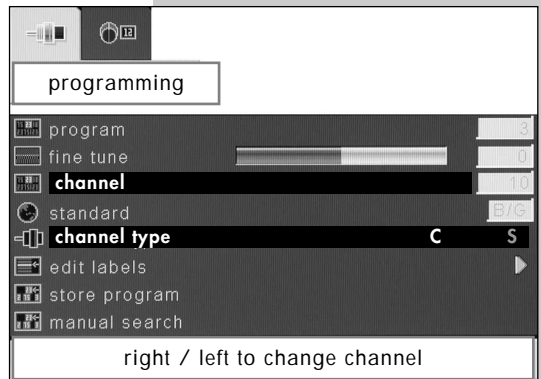
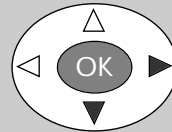

TV



Open the menu

MENU

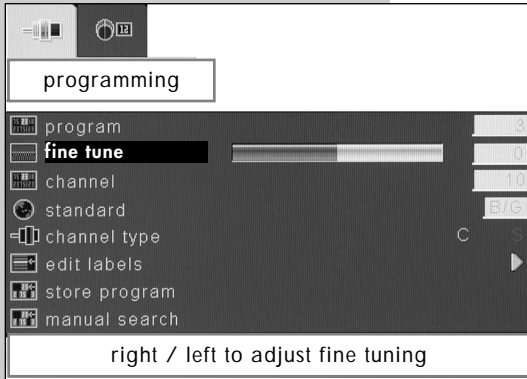
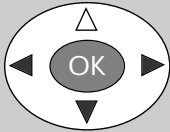

TV



6. Tuning to TV stations

Fine tuning

The TV set is normally tuned to the centre frequency of each of the TV channels. This is usually satisfactory. If you are not satisfied, you can carry out fine tuning of the frequency.

Executing fine tuning

- Switch to the programme position you wish to adjust.
- Press the "**MENU**" key to open the TV menu.
- Use the cursor key **▶** to select the menu item "Settings".
- Use the cursor key **▼** to select the menu item "TV tuner".
- Press the "**OK**" key and open the sub-menu "Programming".
- Use the cursor key **▼** to select the menu item "Fine tuning".
- Use the cursor key **◀▶** to carry out fine tuning.
- If you want to save the fine-tuning setting, use the cursor key **▼** to select the menu item "Store program".
- Then press the cursor keys **◀▶** to save the setting.
- Press the "**TV**" key to close the TV menu.

6.1 Station logo

Open the menu

Each station which transmits VPS signals automatically receives a station logo with up to four characters. If this automatic assignment does not work, or if you want a different logo, you can enter the logo manually.

Setting the station logo

- Switch to the programme position for which you want to set the logo.
- Press the "INFO" key.
- Press the yellow key and switch to edit mode.
- You can either delete the entire station logo with the "AV" key or use the cursor key ◀▶ to select the individual characters of the logo and then use the cursor key ▲▼ to change these characters.
- Press the "TV" key to close the TV menu.

 ***The setting is saved automatically when you close the TV menu.***

INFO

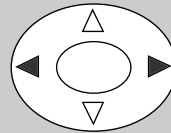

Open the menu

INFO

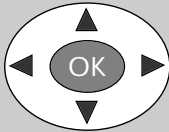

program table		
01 ARD	11 S08	21 S11
02 ZDF	12 S09	22 S12
03 RTL2	13 S10	23 S15
04 TRT 1	14 C05	24 S16
05 CNN	15 C06	25 S17
06 TVPOL	16 C07	26 S18
07 EUROS	17 C09	27 S19
08 C02	18 C10	28 S20
09 S05	19 C11	29 S21
10 S06	20 C12	30 S22

● Delete ● Insert ● Name

TV



6.2 Sorting the stations

In the station table, you can shift or delete individual stations.

Shifting and deleting stations

- Press the "INFO" key to open the station table.
- Use the cursor key ◀▶▲▼ to select the station you want to shift or delete.
- To delete this station, press the red key and, in the menu, press the "OK" key to confirm that you want to delete it.
- To move the selected station, press the green key. The frame around the selected station changes from red to yellow, indicating that it can be moved.

- Use the cursor key ◀▶▲▼ to move the station logo in the yellow frame to the new position.
- Press the green key to insert the station at this position.

 **All other programme positions are shifted as necessary to make space for the inserted station!**

- Press the "TV" key to close the station table.

7. Programme selection

Programme selection and programme-position management

Your TV set can manage a maximum of 100 programme positions (0-99) in the station table. You can select these programme positions with the **numeric keys**, the "**P+ / P-**" keys or from the station table.

When you press a **numeric key**, you have three seconds to enter any further digits.

Programme selection from the station table

In normal TV mode, you can open the station table by pressing the "**INFO**" key. In the table which is then displayed, you can use the cursor key ◀▶ ▲ ▼ to select a programme. The selected programme is then displayed on the screen.

Back to the previous programme

You can switch back and forth between the last two selected programme positions with the ↵ key.

Example:

You are currently watching ITV. During the commercials, you switch to BBC with the numeric keys.

You can now switch back and forth between BBC and ITV with the ↵ key.

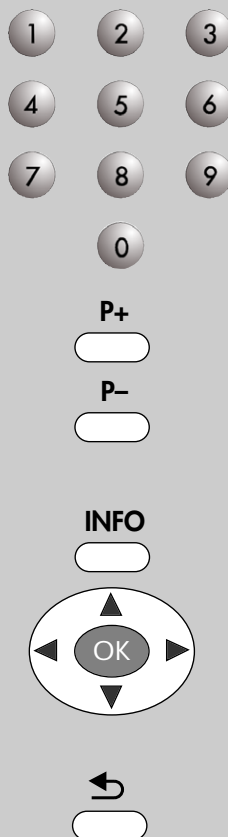

Open the menu

MENU

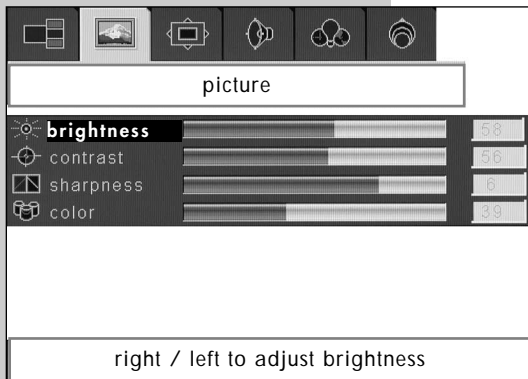
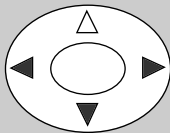

TV



8. Picture settings

The picture settings (brightness, contrast, sharpness, etc.) can be set globally for all programme positions.

Adjusting the picture settings:

- Press the "MENU" key to open the TV menu.
- Use the cursor key ► to select the menu "Picture".
- Use the cursor key ▼ to select the desired menu item "Brightness", "Contrast", "Sharpness" or "Colour".
- Use the cursor key ◀► to adjust the selected picture setting.
- Press the "TV" key to close the TV menu.

The settings are saved automatically when you close the TV menu.

9. Sound settings

Open the menu

The sound settings (volume, headphone volume, balance, etc.) can be adjusted in the menu "Audio".

Adjusting the sound settings:

- Press the "**MENU**" key to open the TV menu.
- Use the cursor key ► to select the menu "Audio".
- Use the cursor key ▼ to select the desired sound setting "Volume", "Headphone volume", "Balance", "Virtual Dolby", "Equalizer", "AVL", "Wide sound" or "Dynamic Bass".
- Use the cursor key ◀► to adjust the selected setting.
- Press the "**TV**" key to close the TV menu.

👉 **The settings are saved automatically when you close the TV menu.**

Virtual Dolby

If you activate the "Virtual Dolby" function, you will hear a simulated surround-sound effect.

Equalizer settings:

The equalizer offers the standard settings "Normal", "Pop", "Rock", "Jazz" and "Classical".

If you are not satisfied with these standard settings, you can configure your own personal setting under "User".

AVL (Automatic volume level)

This function compensates for varying volume levels such as those between the normal programme and the commercials.

Wide sound

For stereo programmes, you can artificially extend the physical distance between the loudspeakers with this option in order to achieve a larger triangle where the stereo sound can be heard correctly.

Dynamic Bass

If this option is active, the bass frequencies are emphasised.

MENU

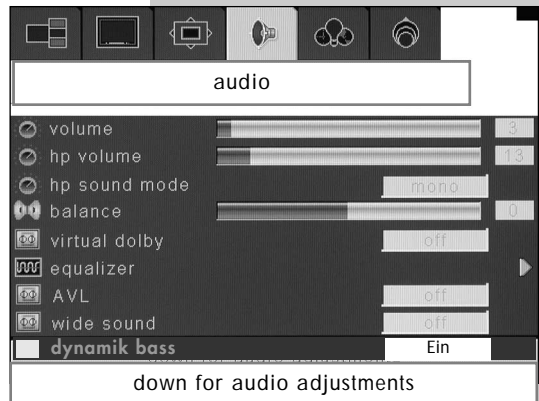
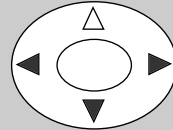

Open the menu

10. Special functions

Picture in Picture (PIP)

The PIP picture can be used to display the programme of a second TV station or a signal from an AV device.

Displaying/hiding PIP:

- Press the red key to display the PIP picture.
- You can use the cursor key ▲ ▼ to select the content of the picture + the selected part of the picture is surrounded by a green frame.
- You can use the **numeric keys** or the "**P+ / P-**" keys to switch to another programme position in the PIP picture.
- You can display a signal from an AV device (such as video recorder or camera) in the PIP picture by pressing the "**AV**" key several times.

- You can zoom the PIP picture in eight steps. To do this, press the yellow key and then use the cursor key ◀ ▶ to increase or decrease the size of the PIP picture.
- You can move the PIP picture to a different position on the screen. To do this, press the green key and then use the cursor key ◀ ▶ to move the PIP picture.

- You can exchange the contents of the PIP picture and the main picture by pressing the white key.
- To hide the PIP picture, press the red key again.

👉 Any changes you have made to the PIP settings are saved automatically when you hide the PIP picture.

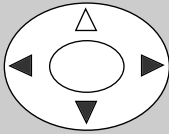



10. Special functions

Picture size

Open the menu

You can use the function "Picture size " to adjust programmes transmitted in various formats to match the wide-screen format of the TV screen.

Adjusting the picture-size:

- Press the  key. The current aspect ratio is displayed at the bottom of the screen.
- Use the cursor key  to select the desired setting. The available options are:

Possible picture-size settings:

Normal:

Programmes are displayed in the standard format 4:3.

Auto: (preferred setting)

The picture is always displayed with the correct aspect ratio (4:3 or 16:9), depending on the input signal. In TV mode, the "Wide Screen Signal" (WSS) is evaluated: if the station does not transmit the WSS signal, the picture is displayed as if the option "Fill screen" were selected.

Fill screen:

Regardless of the transmitted aspect ratio, the picture always fills the full width of the screen.

14:9:

Picture signals in the 14:9 aspect ratio are expanded to fill the full height of the screen, leaving only narrow black stripes at the sides.

Tip: You can use this setting to magnify pictures received in the aspect ratio 4:3. Only a small part of the picture is lost at the top and bottom of the screen.

Letterbox:

This option can be used to expand the picture vertically so that programmes with a black stripe at the top and bottom fill the screen.

Subtitles:

The picture is zoomed and moved slightly upwards so that the subtitles are easier to read.

Zoom:

The picture is zoomed vertically.

 **The setting is saved automatically when you close the TV menu.**

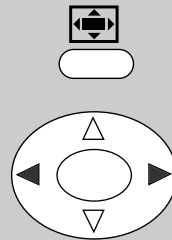

or use the menu "Window"

10. Special functions

Split screen



In "split screen" mode, the screen is divided vertically into two halves.

You can activate and deactivate this mode with the  key.

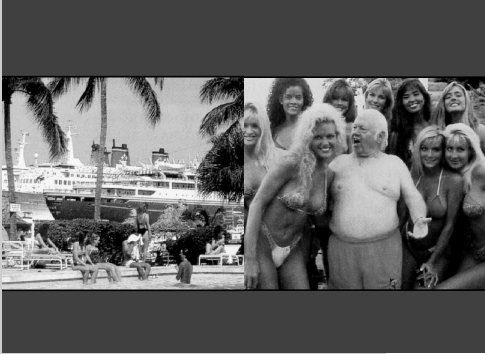

When this mode is activated, you hear the sound belonging to the picture on the left.

You can use the cursor keys **▲ ▼** to select the pictures. The selected picture then has a green frame for a **short time**. You can now change the source of this picture with the **numeric keys**, with the **"P+/P-"** keys or the **"AV"** key. You can also perform picture settings (see Section 8).

You then hear the sound of the selected picture.

When you deactivate this mode with the  key, the TV set is always switched to the station displayed on the left.



 ***The settings are saved automatically when you deactivate this function.***

10. Special functions

Freeze frame

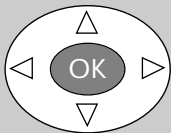

Pressing the **"OK"** key immediately freezes the picture on the screen. The programme (or video film) continues to run in the background.

Press the **"OK"** key again to switch back to the current programme (or video film).

10. Special functions

Sleep timer

Open the menu

By programming the sleep timer, you can determine when the TV set is to switch itself off automatically.

The sleep timer can be set to Off, 30, 60, 90 or 120 minutes.

Setting the sleep timer:

- Press the "**MENU**" key to open the TV menu.
- Use the cursor key ► to select the menu "Options".
- Use the cursor key ▼ to select the menu item "Sleep timer".
- Use the cursor key ◀▶ to set the desired time after which the TV set is to switch itself off.
- Press the "**TV**" key to close the TV menu.

 *The setting is saved automatically when you close the TV menu.*

MENU

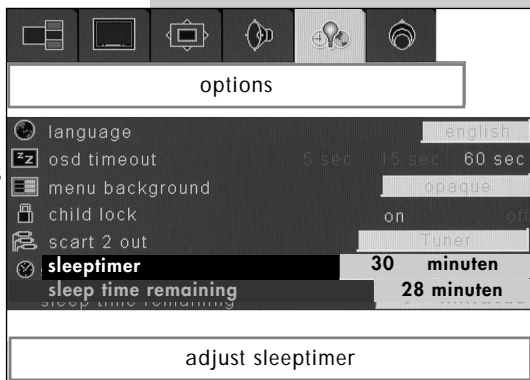
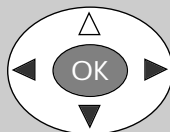

TV



10. Special functions

Display the time

If you are watching a station which transmits Teletext, you can display the current time by pressing the  key.

The time cannot be displayed when you are watching a station which does not transmit Teletext.

The time display disappears automatically after about four seconds.



11. Teletext

i

Teletext is an additional, free information service which is provided by many TV stations. You can scroll through the pages of this "electronic newspaper" in various ways.

TEXT



Displaying Teletext:

- Press the "TEXT" key.
Page 100 (Contents page) of the Teletext is displayed on the screen.

Navigating through Teletext with pages displayed:

- You can step through the subjects by pressing the blue key.
- You can step through the sections of a subject by pressing the yellow key.
- You can step backwards through the Teletext pages by pressing the red key.
- You can step forwards through the Teletext pages by pressing the green key.

To select a specific page, enter the page number with the **numeric keys**.

Sub-pages are automatically scrolled.

Picture in Teletext:

- Press the "TEXT" key.
Page 100 of the Teletext is displayed on the screen.
- Press the "TEXT" key again. A PIP picture containing the currently selected programme position is displayed on the left of the screen.

Hiding Teletext:

- Press the "TV" key or the "TEXT" key.

12. AV devices - Connecting facilities

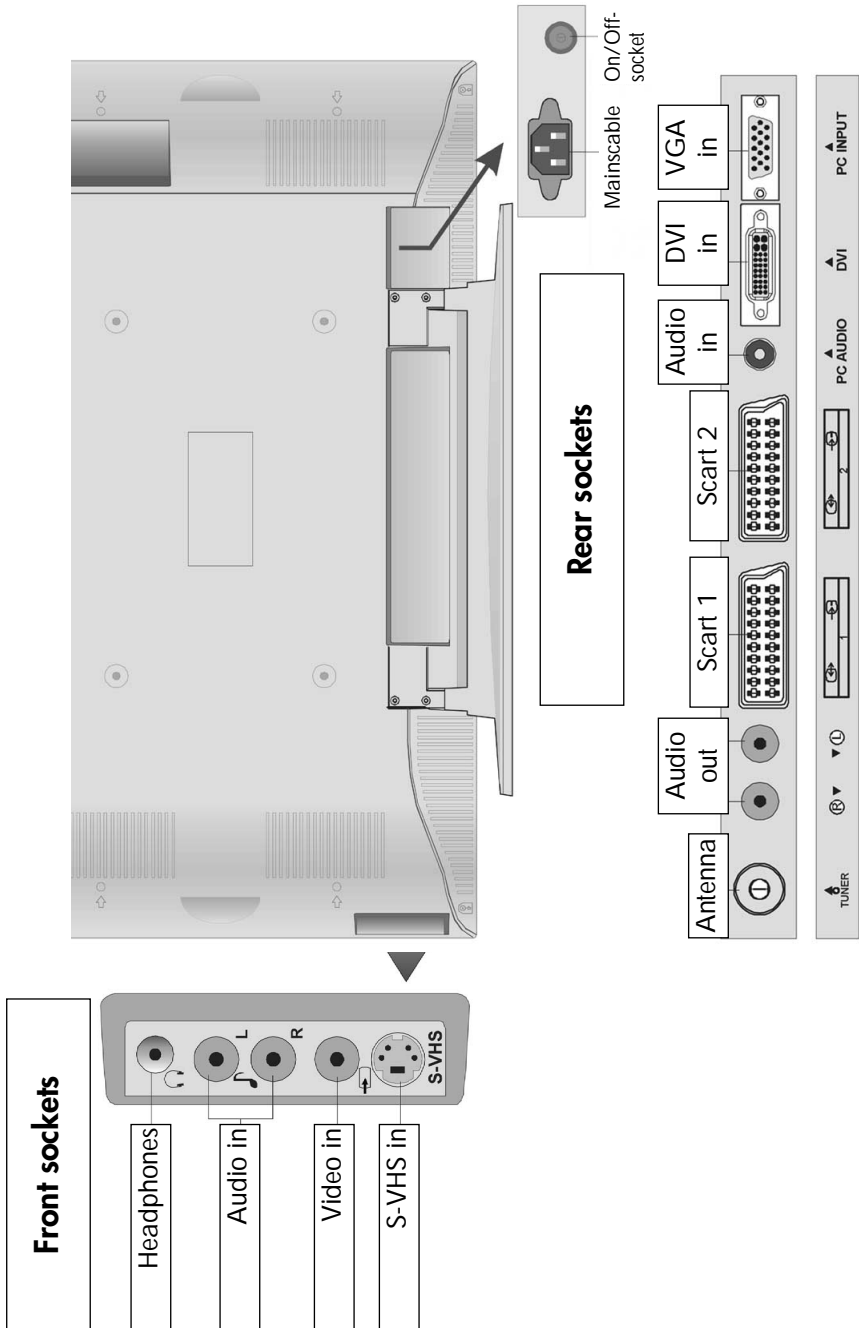

Open the menu



oder

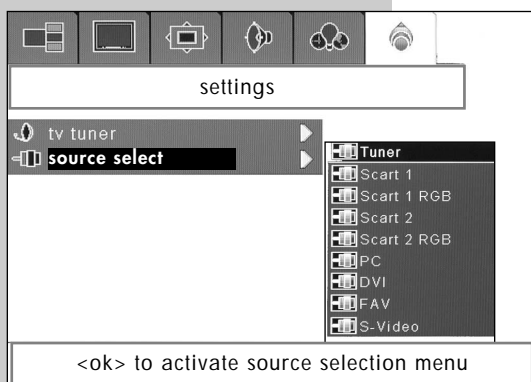
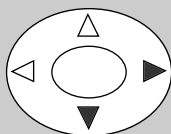

12. AV devices

AV (Audio/Video) **devices** are external devices (such as video recorders, DVD players, decoders, video cameras, etc.) which generate picture and/or sound signals and can be connected to a TV set.

Video recorders, DVD players and similar devices can be connected to the Scart 1 or Scart 2 socket. Decoders must always be connected to the Scart 1 socket.

If an AV device connected to one of the Scart sockets generates a suitable switching voltage, the TV set **automatically switches to AV mode** when the device is switched to playback mode (composite-video signal).

For AV devices connected to the front sockets, you must switch the TV set to AV mode manually in order to display their signals.

For AV devices connected to the front sockets, you must switch the TV set to AV mode manually in order to display their signals.

Selecting AV mode manually

- Press the "**AV**" key several times to step through the AV programme positions to the desired position

- or -

- Press the "**MENU**" key to open the TV menu.

- Use the cursor key **▶** to select the menu "Settings".
- Use the cursor key **▼** to select the menu item "Select source".
- Press the "OK" key and open the sub-menu "Select source".
- Use the cursor key **▲ ▼** to select the source (the socket to which the desired AV device is connected).
- Use the cursor key **▶** to activate this source.
- Start the AV device in the desired mode.

12. AV devices

Possible selections

- Tuner
The signal from the TV station to which the TV set is tuned is displayed.
- Scart 1/2
The picture from the AV device connected to the Scart1 socket is displayed in the composite-colour picture signal.
- Scart 1/2 RGB
The picture from the AV device connected to the Scart1 socket is displayed in the RGB picture signal.
- PC und DVI
The picture from the connected PC is displayed.
The picture size and position can be adjusted in the menu **"Window"**.

The brightness, contrast and phase (adjustment for picture sharpness, executed automatically when a PC is connected) can be adjusted in the menu **"Picture"**.

- FAV (front AV socket)
The picture from the AV device connected to the front AV socket is displayed in the composite-colour picture signal.
- S-Video
The picture from the AV device connected to the front AV socket is displayed in the S-Video (YC) picture signal.

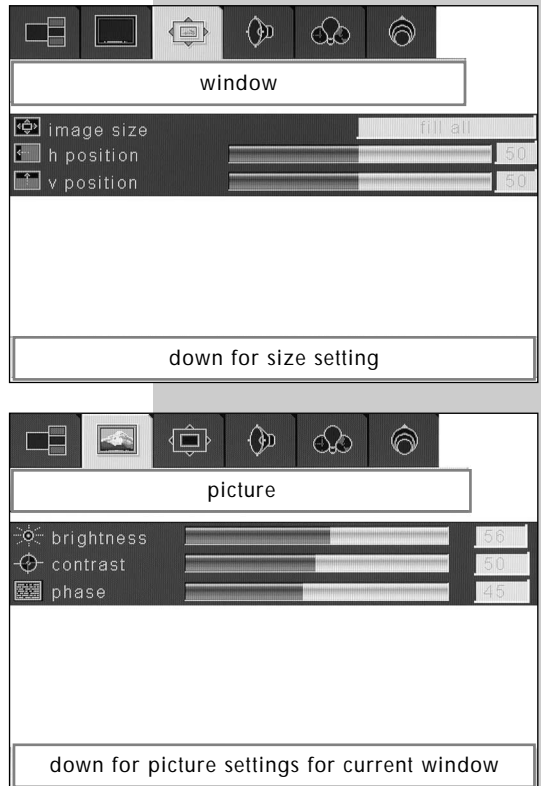

Open the menu



12. Copying AV recordings

Your TV set has a copy mode in which an AV device connected to the Scart 2 socket can record the picture and sound coming from an AV device connected to the "FAV" (Front AV socket) or to the Scart 1 socket.

Selecting the Scart 2 socket as the output:

- Press the "MENU" key to open the TV menu.
 - Use the cursor key ► to select the menu "Options".
 - Use the cursor key ▼ to select the menu item "Scart 2 output".
 - Use the cursor key ◀▶ to select the socket to which the device being used for playback is connected.
- Switch the recording device to record mode and then press "Play" on the playback device.
 - Press the "TV" key to close the TV menu.

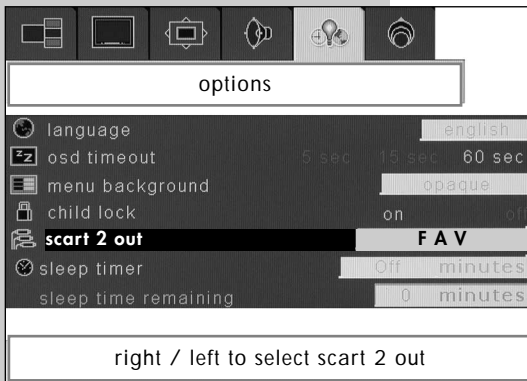

The settings are saved automatically when you close the TV menu.

TV



12. AV devices

Open the menu

Picture quality when playing back pictures from tape

The VCR function ensures an optimal picture quality when playing back recordings from tape devices such as camcorders or video recorders.

☞ *The VCR function in the menu "Options" can be selected only if, for example, the connected video recorder is delivering a signal.*

Activating the VCR function

- Start the playback function on the AV device.
- Press the "**MENU**" key to open the TV menu.
- Use the cursor key ▶ to select the menu "Options".
- Use the cursor key ▼ to select the menu item "vcr".
- Use the cursor key ◀▶ to switch the function on or off.
- Press the "**TV**" key to close the TV menu.

☞ *The setting is saved automatically when you close the TV menu.*

MENU

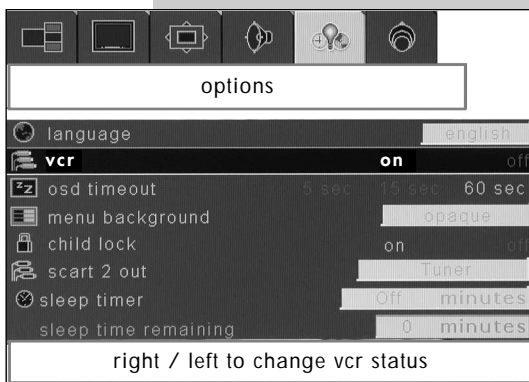
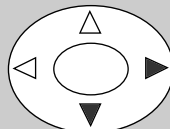

13. Operation without the remote control

This facility is provided only as an emergency measure for use in cases where the batteries of the remote control are flat or where the remote control is not easily available.

 **The local controls are located on the top of the TV set.**

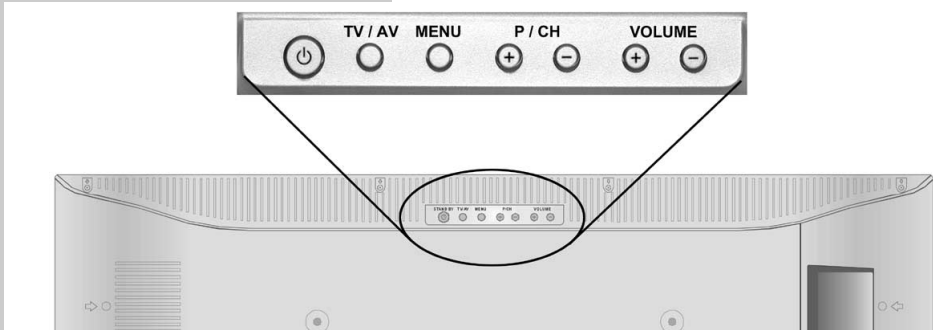

Switching on:

Press the mains switch on the TV set to switch it to standby mode (see Page 29).

Programme selection:

Press the "**P/CH +**" or "**P/CH-**" button.

Volume:

Press the "**Volume +**" or "**Volume -**" button.

Menu:

Press the "**Menu**" button. The use the "**P/CH +**", "**P/CH -**", "**Volume +**" and "**Volume -**" buttons to navigate through the menu.

TV/AV:

You can switch between TV mode and AV mode with the "**TV/AV**" button.

13.1 Key lock (child lock)

With the function "Key lock", you can disable the local controls on the front of the TV set.

This makes it possible to indirectly prevent use of the TV by other persons (such as children) by activating this function and hiding the remote control.

Setting the key lock:

- Press the "**MENU**" key to open the TV menu.
- Use the cursor key ► to select the menu "Options".
- Use the cursor key ▼ to select the menu item "Key lock".
- Use the cursor key ◀► to switch the key lock on or off.
- Press the "**TV**" key to close the TV menu.

👉 ***The setting is saved automatically when you close the TV menu.***

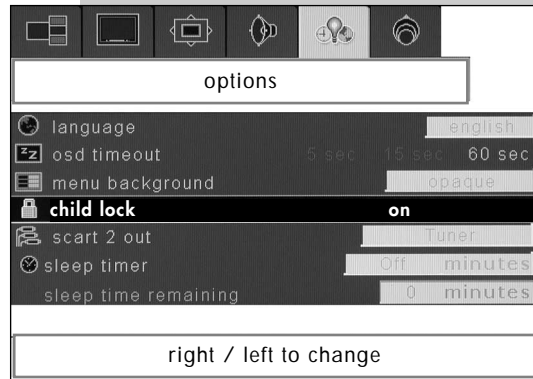

14. Connecting headphones

The headphone socket is located on the front of the TV set (on the right).

We recommend that you use headphones with an impedance of at least 32 Ω . If you use headphones with a lower impedance (approx. 8 Ω), the dynamic range will be lower.

In the case of dual-language programmes, you can listen to sound channel 1 or 2 on the headphones, regardless of which is selected for the internal loudspeakers.

You can adjust the headphone sound settings in the "Audio" menu (see Section 9).

15. Cleaning the set

- ☞ ***Before cleaning the set, always switch it off with the mains switch!***
- ☞ ***Incorrect treatment and cleaning of the screen surface can cause irreparable damage to it. You should therefore always observe the following instructions for treatment and cleaning of the set.***

Treatment:

Always treat the screen surface very carefully.

Take care not to damage it mechanically by shocks, impact, scratching or scraping.

Keep sharp, pointed and hard objects away from the surface of the screen.

Keep the surface of the screen clean.

For cleaning the case and the screen, use only a soft, dry cloth. For removing stubborn marks, you may moisten the cloth slightly.

Cleaning and care:

Always switch off the TV set and remove the mains plug from the wall outlet before cleaning.

The surface of the screen may be cleaned only with a soft, dry cloth (such as a microfleece duster). If any marks cannot be removed with this dry cloth, you may moisten the cloth slightly.

Take care that no water or other liquid can enter the TV set, since this can cause serious damage to the set.

If any liquid or other foreign object (pieces of metal, etc.) enters the set, immediately disconnect the mains plug from the wall outlet.

Never insert your hands or tools into the set, since this may result in electric shocks.

16. Technical data

Mains voltage:

220 - 240 V ~ 50 Hz

Antenna input:

75 Ohms asymmetrical

DIN 45325

Tuning range:

Standard channels 2 - 12, 21 - 69

Special channels S1 - S20, S21 - S41

S42 ... S46 (Belgium: channels OIR)

Power

consumption:

	Power consumption (to CENELEC / TC 59 X):	Music output power to DIN 45324 into 4 Ohms at 1 kHz (sinus output power):
	ap. 148 W	2 x 12 W (2 x 8 W)

Energy consumption per hour (Wh):

See power consumption in W multiplied by 1 hour

Standby: ca. 2,5 Wh

TFT-LCD screen:

WXGA resolution (1280x768)

Contrast ratio (typically 500:1)

Brightness 500cd/m²

Reaction time 16 msec.

Screen colours 16.7 million

Dimensions:

TV set with base (H x D x W)

523 mm x 256 mm x 847 mm

Errors excepted. Subject to changes !

Disposal of batteries

Dry or rechargeable batteries should never be discarded as normal garbage!

Please use the local facilities for the disposal of exhausted batteries.

Make sure the batteries are fully discharged before disposal.

The batteries are generally fully discharged when the unit in which they are used

- switches itself off or indicates "Battery flat"

or

- no longer operates correctly when the batteries have been in use for a long time.

In order to avoid short-circuits, the poles of the batteries should be covered with a piece of adhesive tape.

Batteries which contain dangerous substances are marked as follows:

Pb = battery contains lead

Cd = battery contains cadmium

Hg = battery contains mercury

Li = battery contains lithium



Problem	Possible cause	Remedy
<p>The TV set does not react to commands from the remote control.</p>	<ul style="list-style-type: none"> • There is an obstacle between the remote control and the TV set. • Sunlight is shining directly on the infrared sensor in the TV set. • The batteries in the remote control are flat. • The TV set is not switched on with the mains switch. • Fault in the internal processor. 	<ul style="list-style-type: none"> • Remove the obstacle. • Ensure that the sun does not shine on the set. • Install new batteries. • Switch on the TV set with the mains switch. • Switch the TV set off with the mains switch, wait a few seconds and then switch it on again.

Code list

Codes		Video			
M etz VG61	532				
VF21, VF44, VF46					
VF61, VE21, VE43					
VE44, VE45, VD21					
VD43, VD44, VD45					
VC21, VC43, VC44					
VC62, 21VB11					
42VB12, 21VA12					
21VA13, 42VA11					
64VA14, 9836, 9837					
9847, 9874, 9875					
9876, 9877					
M etz VF22, VF47	568				
VF48, 9843, 9844					
9849					
M etz VH22, VH47	573				
VH48					
A CTION	468	481	547		
ADMIRAL	481	487			
ADVANTZ	481				
ADVENTURA	468	481	547		
ADYSON	487				
AGHA	547				
AIWA	481	505	562	572	
	477				
AKAI	481	482	483	484	
	505	508	546	554	
	575	609	612		
AKIBA	487				
AKURA	487	505			
ALBA	466	588	593		
ALLORGAN	547				
ALLSTAR	529				
AMWAY	529				
ANITECH	487	490	529		
ART TECH	575				
ASA	478	481	528		
ASBERG	575				
ASTRA	481	547			
ASUKA	481	487			
ASUKA	527				
ASWO	528				
AUDIO DYNAMICS	505				
AUDIOSONIC	575	616			
AUDIOTON	466				
AUDIOVOX	481				
AVIS	487	547			
B AIRD	505				
BANG & OLUFSEN	503	583			
BASIC LINE	487				
BAUR	513	547	565	599	
	607	609	612		
BEAUMARK	547				
BELL & HOWELL	468				
BESTAR	466	616			
BLACK PANTHER	616				
BLAUPUNKT	491	496	502	507	
	508	527	530	532	
	607	609	610	612	
	614	621			
BONDSTEC	466	487			
BONDSTECBRANDT	505				
BRANDT ELECTRONIQUE	503	504	505	524	
	574				
BRAUN	570				
BRIONVEGA	450	575			
BROKSONIC	481				
BRUNS	466	487	490		
BUSH	588	590	593		
C ALIN	481				
CALIX	481				
CANDLE	481				
CARRERA	547				
CARVER	527				
CGE	505				
CIE	487				
CIMLINE	487	481	487	547	
CLARIVOX	606				
CLASSIC	481				
CLATRONIC	466				
COLORTYME	547				
COLT	487				
CONDOR	466	616			
CONTINENTAL EDISON	503	504	505		
CRAIG	481	487	547		
CROSLEY	481	507	527	547	
CROWN	487				
CROWN	490	575	616		
CRYSTAL	575				
CTC	466				
CURTIS MATHES	505	547			
CYBEREX	547				
D AEWOO	466	468	553	616	
DANSAI	487				
DAWA	575				
DAYTRON	466				
DE GRAAF	529				
DECCA	528				
DECCAVIDEO	528				
DENON	527				
DIGITAL	477	481	505		
DORIC	601				
DTS	547				
DUAL	503	504	505	527	
	530				
DUEL	505				
DUMONT	468	481	487	527	
DYNATECH	487				
E CONOMIC	510				
EDISON	487				
ELBE	616				
ELCATECH	487				
ELECTROHOME	481	547			
ELECTROPHONIC	481				
ELIN	547				
ELTA	487	616			
EMERSON	481				

Code list

EPC	505	586	598		JENSEN	505			
ESC	466	510	616		JETPOINT	575			
ETZUKO	487				JVC	503	504	505	519
EUROPHON	586					520	545		
EXPERT	604				JVC_LCD	515	521		
F ERGUSON	501	505	523	524	K AISER	575			
	555	574	595	596	KAISUI	487			
FIDELITY	487				KAPSCH	600	601	603	
FINLUX	468	477	478	528	KARCHER	575			
FIRST LINE	477	481	487	575	KENDO	483			
FISHER	468	473			KENWOOD	468	505		
FUNAI	481	487	571		KLH	481	487		
G AB	487				KLIT	487			
GBC	466				KODAK	481			
GE	547				KORPEL	487			
GEC	528	601	603	604	KUBA	473	504	505	510
GELOSO	466				L EYCO	487			
GITEM	575				LG	578			
GOLDHAND	487	490			LIESENKOTTER	575	565		
GOLDSTAR	468	481	547	552	LLOYD	481	487	547	
	556	575	610		LLOYD'S	601	606		
GOODMANS	466	487	530	616	LOEWE	481	491	575	
	617	621			LOEWE OPTA	481	491	527	
GRAETZ	468	505	600	603	LOGIK	487	509	547	
GRANADA	468	474	477	532	LUXOR	468	478	483	517
	542	557	565	575		518	601		
	601	605	606	616	LXI	468	477	481	
GRANDIN	481	487	604		M AGNADYNE	575			
GRUNDIG	451	452	453	454	M ELECTRONICS	547			
	457	458	459	460	MAGNASONIC	470	481	487	547
GRUNDIG	461	462	463	464	MAGNAVOX	481	507	527	547
	491	492	493	495	MAGNIN	481	547		
	496	497	507	527	MAGNUM	581	582		
	530	531	563	584	MANESTH	487			
	585	600	606	609	MARANTZ	491	528	565	566
	610	611	612	613	MARQUANT	487	490		
GUTTRONIC	602				MARTA	481			
H ANSEATIC	481	575			MATRIX	481			
HANTAREX	575				MATSUI	486	509	560	561
HARLEY DAVIDSON	481					562	586	601	610
HARVARD	481	487			MATSUSHITA	527			
HCM	466	487	490		MEDIATOR	527			
HEADQUARTER	468				MEMOREX	468	481	547	
HINARI	487	509			MEMPHIS	487			
HINARIHITACHI	475	476	477	478	MGA	547			
HITACHI	481	485	503	505	MGN	547			
	530	535	601	603	MINERVA	606	609	610	612
	604				MINOLTA	477			
HYPSON	487				MITSUBISHI	477	505	519	527
I MPERIAL	510	575				542	609	612	
INGERSOL	509					487	547	468	477
INNO HIT	510	547	575			481			
INNO HIT	616				MULTITECH	466	481	487	575
INTERBUY	481	487			MURPHY	601			
INTERDISCOUNT	575				N AD	547			
INTERFUNK	468	527	565	575	NATIONAL	507			
	600	601	603	604	NEC	504	505	576	
INTERVIDEO	466				NECKERMANN	450	469	470	477
INTERVISION	487					491	493	496	505
IRRADIO	481	487	575	606		509	510	512	513
ITT	450	468	483	505		519	528	541	565
ITV	466	481							

Code list

	575	610	611	616	QUELLE	478	484	487	491
NEI	575					496	497	503	504
NESCO	487					505	508	509	510
NIKKAI	466					512	513	519	528
NIKKO	481					529	541	565	575
NOBLIKO	606					599	604	606	609
NOKIA	450	468	470	483		610	611	612	614
	488	489	503	504		616	621		
	505	510	516	517	QUESTAR	466			
	518	547	551	553	R ADIALVA	481	487	527	
	554	557	567	600	RADIOLA	527	575		
	601	603	604		RADIONETTE	601	604		
	500	503	504	505	RADIX	497			
	515	521	524	574	RANDEX	481			
NOVATRONIC	602				RANDIU	481			
	575				RANK/BUSH/MURPHY	601			
O CEANIC	483	489	601	604	RCA	477	481	483	547
OKANO	487				REALISTIC	468	481	547	
OLYMPIC	466				REDIFFUSION	601			
OLYMPUS	507				REX	503	505		
ORION	481	509	531	536	RICOH	481			
	537	538	558	559	ROADSTAR	481	487	547	617
	560	561	589	591	ROYAL	466	487		
OTTO VERSAND	527	474	493	496	S ABA	499	503	504	505
	508	512	513	541	SABA	515	521	524	540
	544	565	575	599	SABA	574	601	603	
	609	610	611	612	SAISHO	486	509	575	
	616	620	621		SALORA	467	468	470	483
P AEL	606				SALORA	516	517		
PALLADIUM	481	487	491	505	SAMBERS	606			
PANASONIC	507	508	527	532	SAMEX	547			
	533	549	600	601	SAMSUNG	510	547	575	575
	623					597			
PATHE MARCONI	503	505			SANKY	487			
PAXSONIX	547				SANSUI	487	505	575	
PENNEY	477	481	527	547	SANWA	509			
PENTAX	477				SANYO	468	469	470	471
PERSHIN	606					551	577	586	
PHILCO	481	507	527	547	SBR	527			
PHILIPS	481	491	507	528	SCHAUB LORENZ	450	468	483	505
PHILIPS	529	530	547	548	SCHNEIDER	477	478	481	487
PHILIPS	550	563	564	565		510	527	529	530
PHILIPS	568	575	620	621		563	564	569	571
PHILIPS	624	625				573	575	578	581
PHILIPS (F)	491	565	575			582	604		
PHONOLA	527				SCOTT	481			
PILOT	481				SEARS	468	477	481	
PIONEER	477	527	539	575	SEG	487	490	510	547
PRIMA	505	547			SEI-SINUDYNE	509	528		
PROFEX	487	490	529		SELECO	503	504	505	545
PROFILE	547				SENTRA	466			
PROSCAN	477	481	483	547	SETRON	466	487		
PROTEC	487				SHARP	468	544		
PULSAR	481	547			SHINTOM	487			
PULSER	468	481	547		SHIVAKI	481	575		
PYE	565	575			SHOGUN	547			
Q TY1	592				SHORAI	509			
QUARTER	468				SICE	609	612		
QUARTZ	481	547			SIEMENS	459	461	462	464
QUASAR	507	527				468	469	470	472
QUELLE	450	459	461	464		479	480	481	486
	470	471	474	477		491	492	493	494

Code list

SIEMENS	495	496	497	498	TRIAD	575			
	511	525	530	584	TRIX	481			
	607	609	610	611	TVA	466			
	612	614			U HER	466	477	481	503
SILMA	575					505	510	543	
SILVA	481				ULTRAVOX	450	616		
SINGER	487	547	575	616	UMA	565	575	601	604
SINUDYNE	509	513	527	575	UMA	606	609	612	614
	599				UNITECH	547			
SOLAVOX	466	604			UNITED	560			
SONOKO	575				UNIVERSUM	481	483	491	527
SONOLOR	601					530	547	571	575
SONTEC	481					606	609	612	621
SONY	506	512	513	514	UNIVOX	604			
	541	599	623		V ICTOR	505	545		
SR1000	547				VIDEOMASTER	466			
STS	477				VIDEOPLUS	554	562	589	
SUNWOOD	487				VIDEOSONIC	547			
SYLVANIA	527				VIEWMARK	481			
SYMPHONIC	481	487	527		VIEWMAX	481			
T AISHO	509				W ARDS	477	487	547	
TALENT	609	612			WEGAVOX	575			
TANDBERG	623				WELTBlick	481			
TANDY	468				WHITE WESTINGHOUSE	450	565		
TASHIKO	528	529			WINSTON	575			
TATUNG	505	527			WIZJA	528			
TEAC	505				WORLDVIEW	575			
TEC	466				X R1000	487	547		
TECHLINE	487				Y AMISHI	487			
TECHNICS	527	532			YOKAN	487			
TECHNILAND	575				YOKO	466	481	487	490
TECHNISAT	563					510	547		
TEKNANT	575				Z ENITH	481			
TEKNIKA	481								
TELEAVIA	503								
TELEAVIA	505								
TELEFUNKEN	500	503	504	505					
	515	521	524	574					
	579	594							
TELEORDER	547								
TELERENT	505								
TELESERVICE	609	612							
TELETECH	487								
TENOSAL	487								
TENSAI	481	487	490	509					
	575	593							
THOMAS	547								
THOMSON	499	500	503	504					
	505	524	574	594					
	60	6226							
THORN	474	482	501	503					
	505	542	565	575					
	586	604	606	609					
	612								
THORN-FERGUSON	501	503	504	505					
	575	601	604	606					
	609	612							
TOKAI	481	487							
TOSHIBA	474	481	505	527					
	547								
TOTEVISION	481	547							
TOWADA	487	490							
TOWIKA	487								

Codes DVD-Player

M ETZ	204	239		
A KAI	214			
B LUESky	254			
Boxford	256			
C YBER HOME	223			
Cytron	247			
D ENON	216	230		
D-I-K	243			
DUAL	248			
E MERSON	263			
G AME	253			
GOLDSTAR	262			
GRAND PRIX	255			
GRUNDIG	222	232	238	
H ARMAN/KARDON	206			
HITACHI	205	210	260	261
J VC	212			
K ENWOOD	208	246	231	263
KISS	270			

Code list

LABWAVE	200	201			DIORA	949			
LG	263				DUAL	822	832	859	994
LINN	215				FISCHER	830	831	920	953
LOEWE	219				GOLDSTAR	885			
MARANTZ	218	219	236		GOODMANN'S	872			
MbyN	271	272			GOODMANN'S	888			
MEDIENCOM	241				GRUNDIG	908	911	912	913
MEDION	221	228			HARMAN KARDON	905	931	934	935
MEGATON	240				HITACHI	853			
MUSTEK	256	257	258		INTERSOUND	960			
MYRYAD	269				ITT	937			
NAD	207				JVC	844	848	849	902
NONAME	228					903	904	992	
ONKYO	209	225	226		KENWOOD	820	847	858	859
ORION	266					877	878	879	925
PANASONIC	216	267	274	275		948	963		
	276				KRELL	908			
PHILIPS	219	220	227	233	LINN	908	964		
	234	235	236	237	LUXMAN	924	946	967	
	278				METZ HE11	882			
PIONEER	203	204	249	250	MARANTZ	833	908		
	251				MATSUI	908			
PROLINE	228	273			MEDION	955			
SAMSUNG	210	268			MERIDIAN	908			
SCHAUB LORENZ	255				MAGNAVOX	908			
SCHNEIDER	244	248	263		MICROMEGA	908			
SEG	201				MINOWA	972			
SHERWOOD	224	263			MISSION	908	909		
SILVA SCHNEIDER	243				MTC	955			
SONY	211	229	264	265	NAD	947			
SUNKAI	242				NAIM	908			
TECHNICS	216	217			NAKAMICHI	930			
TEVION	228	259			NOKIA	938			
THOMSON	213	277			NONAME	888			
TOSHIBA	202	245	246		NSM	802	803	804	805
UNITED	252	255	266			806	807		
YAMAHA	216	278	234		OKANO	869	871		
					ONKYO	819	827	861	881
Codes HI-FI - CD					PALLADIUM	810	851	866	870
AIWA	815	816	817	884	PANASONIC	834	915	918	
AKAI	856	857	872	921	PHILIPS	833	908	909	911
AKKAI	856					965			
AMSTARD	957				PIONEER	824	825	826	850
AMSTRAD	929	940	942	956		862	863	864	922
ARCAM	908					923			
ASWO	909				PMG	906			
BANG & OLUFSEN	808				PROTON	908			
BRAUN	975	976			QUAD	908	965		
BUSH	888				QUAD	908	965		
CAMBRIDGE	945				RADIOTONE	958			
CAMBRIDGE AUDIO	945				RADMOR	911			
CARVER	908								
DAEWOO	876								
DENON	801	812	845	846					
	853	899	900	901					
	961	962							

Code list

	947	950	951	952	NAD	459			
	953	954	955	956	NAKAMICHI	419			
	964	976			NONAME	748			
SONY	865	925	965	966					
	967	968	969	991	O KANO	733	736		
	992				ONKYO	379	440	460	742
T +A	871	961			P ALLADIUM	731	735		
T+A ELEKTROAKUSTIK	961				PANASONIC	371	432	451	
TECHNICS	838	898	981	983	PHILIPS	427	450		
THOMSON	852				PIONEER	383	384	436	437
						996	997	998	999
U NIVERSUM	868	875	886	895	R EVOX	386			
	947	950			REVOX/STUDER	427			
Y AMAHA	857	858	859	914	RADMOR	428			
	924	932			ROTEL	378			
Codes HI-FI - Tuner					S AMSUNG	411	463	465	473
A IWA	376	377	745			475	476		
AKAI	734	737	993		SANYO	433	990	995	
AMSTRAD	452	455	464	468	SCHNEIDER	374	380	388	390
	469					391	392	393	394
ASH	744					395	396	397	398
ASWO	427					399	400	401	402
						403	404	407	408
B ANG & OLUFSEN	369					409	412	441	442
BUSH	748					443	469	470	732
						733	735	746	748
						749			
D AEWOO	458	739			SHARP	373	446		
DENON	371	372	423	424	SHERWOOD	413	456	457	
	445	471	991		SIEMENS	426	427	477	478
DIORA	461					479	480	732	733
DUAL	370	381	994			737	738	739	746
						747			
F ISCHER	434	449			SINOTEC	749			
					SINOTEC (PEPSI-DOSE)	749			
G OLDSTAR	746				SONY	389	416	420	421
GOODMANN'S	737					422			
GOODMANS	748				SUPERTECH	466			
GRUNDIG	427	429	450						
H ARMAN KARDON	418	730			T +A	405	743		
HITACHI	453	991			T+A ELEKTROAKUSTIK	743			
					TECHNICS	387	430	431	462
I TT	412				TENSAI	406			
					THOMSON	382			
J VC	414	425	444	447	U HER	375			
	448				UNIVERSUM	403	467	473	733
						737			
K ENWOOD	417	439	446	740	Y AMAHA	385	415	435	454
	741	994				992			
L INN	472				Codes HI-FI - Amp				
LUXMAN	438	474			A IWA	777	985	986	
					AKAI	753	754	766	
M ETZ HE11	743				AMSTRAD	785	813	829	831
MARANTZ	450					840			
MINOWA	409				ASH	776			
MISSION	426				ASWO	793			
N OKIA	410								

Code list

BANG & OLUFSEN	996				SAMSUNG	828	837	844	846
BRAUN	960				SANYO	750	756		
BUSH	748	782			SCHNEIDER	763	764	768	779
						782	783	784	785
DAEWOO	770					786	794	812	813
DENON	751	789	790	791		814	815	827	840
	817	988				842	951	953	956
DIORA	835					961	962	963	964
DUAL	952	981	995			965	966	967	968
						969	970	971	972
FISCHER	750	820	839			973	978		
					SHARP	818	990		
GRUNDIG	794	795	804		SHERWOOD	825	832	833	
GOODMANN'S	749	766	782		SIEMENS	762	763	766	767
GOLDSTAR	779					768	769	770	775
						779	780	781	784
HARMAN KARDON	760	823				785	794	800	947
HITACHI	751					948	950		
					SINOTEC	786			
ITT	827				SINOTEC (PEPSI-DOSE)	786			
					SONY	787	788	974	991
JBL	821	975			SUPERTECH	782			
JVC	792	816	819		T+A	774	959		
					T+A ELEKTROAKUSTIK	774			
KENWOOD	755	771	818		TECHNICS	805	806	836	976
						993			
LINN	794	795			TENSAI	958			
LUXMAN	810	845	954	955	THOMSON	980			
					UHER	987			
METZ HE11	774				UNIVERSUM	763	766	838	844
MARANTZ	794	795	798			963			
MEDION	785				YAMAHA	752	809	824	830
MERIDIAN	795						979		
MINOWA	978								
MISSION	799								
NOKIA	826								
NAD	834								
NAKAMICHI	822								
NIAM	795								
NONAME	782								
OKANO	763	765							
ONKYO	772	982							
PALLADIUM	761	783	991						
PALLADIUM/OKANO	764								
PANASONIC	805	808	994						
PHILIPS	793	794	795	796					
	797	798	803	992					
PIONEER	757	758	795						
PRO-LOGIC	957								
QUAD	795								
RADIOTONE	841								
RADMOR	801	802	803						
REVOX	843	977							
REVOX/STUDER	796	797	798						
ROTEL	983	984							
SABA	811								



Metz bietet Qualität Made in Germany:
Unterhaltungselektronik, mecablitz-Blitzgeräte,
Kunststofftechnik sowie Industrieelektronik.

Metz-Werke GmbH & Co. KG
Postfach 1267, D-90506 Zirndorf

Fon: +49 911 - 97060
www.metz.de/info@metz.de

04/28/05

Metz - always first class.

© 604 47 0055.A1